



# RF Power Field Effect Transistors

## N-Channel Enhancement-Mode Lateral MOSFETs

Designed for GSM and EDGE base station applications with frequencies from 1.9 to 2.0 GHz. Suitable for FM, TDMA, CDMA and multicarrier amplifier applications. To be used in class AB for GSM and EDGE cellular radio applications.

- GSM and EDGE Performances, Full Frequency Band  
 Power Gain — 13.5 dB (Typ) @ 90 Watts (CW)  
 Efficiency — 45% (Typ) @ 90 Watts (CW)
- Capable of Handling 10:1 VSWR, @ 26 Vdc, 90 Watts CW Output Power

### Features

- Internally Matched for Ease of Use
- High Gain, High Efficiency and High Linearity
- Integrated ESD Protection
- Designed for Maximum Gain and Insertion Phase Flatness
- Excellent Thermal Stability
- Characterized with Series Equivalent Large-Signal Impedance Parameters
- RoHS Compliant
- In Tape and Reel. R3 Suffix = 250 Units per 56 mm, 13 inch Reel.

**MRF18090BR3**  
**MRF18090BSR3**

**1.90 - 1.99 GHz, 90 W, 26 V**  
**LATERAL N-CHANNEL**  
**RF POWER MOSFETS**

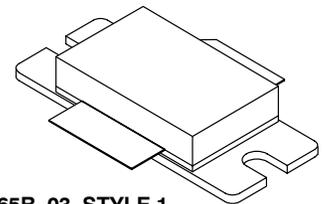

**CASE 465B-03, STYLE 1**  
**NI-880**  
**MRF18090BR3**

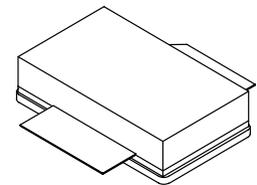

**CASE 465C-02, STYLE 1**  
**NI-880S**  
**MRF18090BSR3**

**Table 1. Maximum Ratings**

Rating	Symbol	Value	Unit
Drain-Source Voltage	$V_{DSS}$	-0.5, +65	Vdc
Gate-Source Voltage	$V_{GS}$	-0.5, +15	Vdc
Total Device Dissipation @ $T_C = 25^\circ\text{C}$ Derate above $25^\circ\text{C}$	$P_D$	250 1.43	W W/ $^\circ\text{C}$
Storage Temperature Range	$T_{stg}$	- 65 to +150	$^\circ\text{C}$
Case Operating Temperature	$T_C$	150	$^\circ\text{C}$
Operating Junction Temperature	$T_J$	200	$^\circ\text{C}$

**Table 2. Thermal Characteristics**

Characteristic	Symbol	Value	Unit
Thermal Resistance, Junction to Case	$R_{\theta JC}$	0.7	$^\circ\text{C}/\text{W}$

**Table 3. ESD Protection Characteristics**

Test Conditions	Class
Human Body Model	2 (Minimum)
Machine Model	M3 (Minimum)

**Table 4. Electrical Characteristics** ( $T_C = 25^\circ\text{C}$  unless otherwise noted)

Characteristic	Symbol	Min	Typ	Max	Unit
<b>Off Characteristics</b>					
Drain-Source Breakdown Voltage ( $V_{GS} = 0\text{ Vdc}$ , $I_D = 100\ \mu\text{Adc}$ )	$V_{(BR)DSS}$	65	—	—	Vdc
Zero Gate Voltage Drain Current ( $V_{DS} = 26\text{ Vdc}$ , $V_{GS} = 0\text{ Vdc}$ )	$I_{DSS}$	—	—	10	$\mu\text{Adc}$
Gate-Source Leakage Current ( $V_{GS} = 5\text{ Vdc}$ , $V_{DS} = 0\text{ Vdc}$ )	$I_{GSS}$	—	—	1	$\mu\text{Adc}$
<b>On Characteristics</b>					
Gate Quiescent Voltage ( $V_{DS} = 26\text{ Vdc}$ , $I_D = 750\text{ mAdc}$ )	$V_{GS(Q)}$	2.5	3.7	4.5	Vdc
Drain-Source On-Voltage ( $V_{GS} = 10\text{ Vdc}$ , $I_D = 1\text{ Adc}$ )	$V_{DS(on)}$	—	0.1	—	Vdc
Forward Transconductance ( $V_{DS} = 10\text{ Vdc}$ , $I_D = 3\text{ Adc}$ )	$g_{fs}$	—	7.2	—	S
<b>Dynamic Characteristics</b>					
Reverse Transfer Capacitance ( $V_{DS} = 26\text{ Vdc} \pm 30\text{ mV(rms)ac}$ @ 1 MHz, $V_{GS} = 0\text{ Vdc}$ )	$C_{rss}$	—	4.2	—	pF
<b>Functional Tests (In Freescale Test Fixture)</b>					
Common-Source Amplifier Power Gain @ 90 W (1) ( $V_{DD} = 26\text{ Vdc}$ , $I_{DQ} = 750\text{ mA}$ , $f = 1930 - 1990\text{ MHz}$ )	$G_{ps}$	12	13.5	—	dB
Drain Efficiency @ 90 W (1) ( $V_{DD} = 26\text{ Vdc}$ , $I_{DQ} = 750\text{ mA}$ , $f = 1930 - 1990\text{ MHz}$ )	$\eta$	40	45	—	%
Input Return Loss (1) ( $V_{DD} = 26\text{ Vdc}$ , $P_{out} = 90\text{ W CW}$ , $I_{DQ} = 750\text{ mA}$ , $f = 1930 - 1990\text{ MHz}$ )	IRL	—	—	- 10	dB

1. To meet application requirements, Freescale test fixtures have been designed to cover the full GSM1900 band, ensuring batch-to-batch consistency.

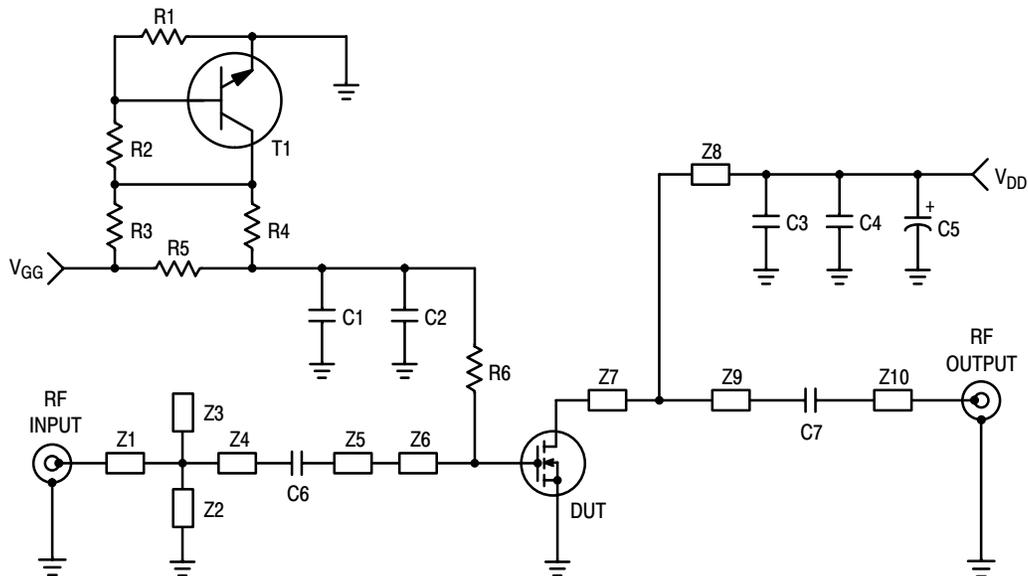

C1	1.0 $\mu$ F Chip Capacitor (0805)	Z2	Printed Inductance
C2	1.0 nF Chip Capacitor (0805)	Z3	Printed Inductance (Butterfly)
C3, C4	6.8 pF, 100B Chip Capacitors	Z4	0.70" x 0.09" Microstrip
C5	220 $\mu$ F, 50 V Electrolytic Capacitor	Z5	0.36" x 0.09" Microstrip
C6, C7	12 pF, 100B Chip Capacitors	Z6	0.21" x 1.25" Microstrip
R1	2.2 k $\Omega$ Chip Resistor (0805)	Z7	0.45" x 1.18" Microstrip
R2, R3, R6	1.0 k $\Omega$ Chip Resistors (0805)	Z8	1.37" x 0.05" Microstrip
R4	10 k $\Omega$ Chip Resistor (0805)	Z9	0.39" x 0.09" Microstrip
R5	6.8 k $\Omega$ Chip Resistor (0805)	Z10	1.25" x 0.09" Microstrip
T1	BC847 SOT-23	PCB	Teflon <sup>®</sup> Glass
Z1	0.85" x 0.09" Microstrip		

Figure 1. 1.93 - 1.99 MHz Test Fixture Schematic

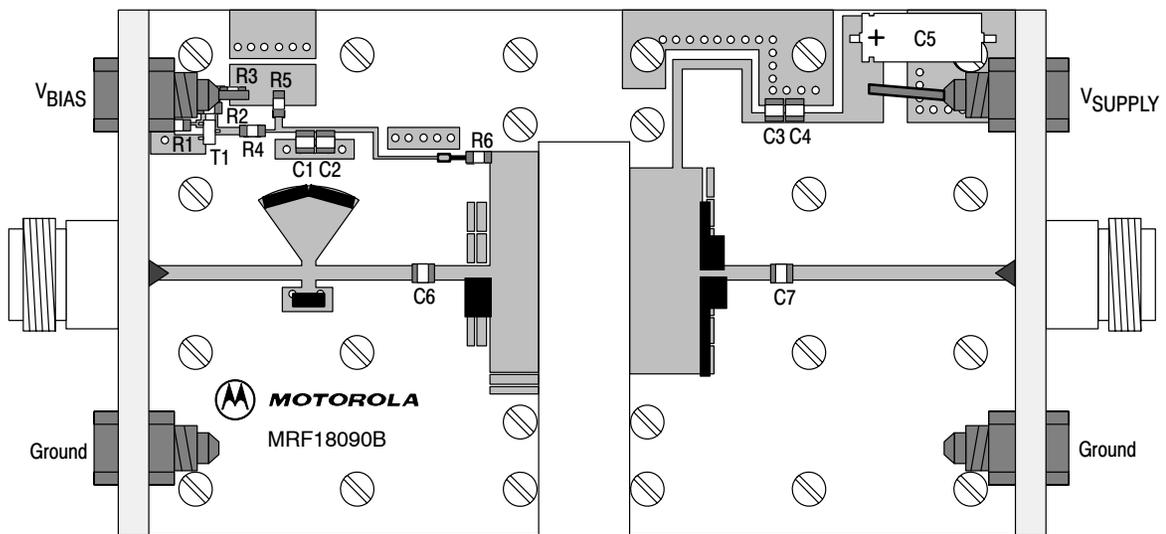

Freescle has begun the transition of marking Printed Circuit Boards (PCBs) with the Freescle Semiconductor signature/logo. PCBs may have either Motorola or Freescle markings during the transition period. These changes will have no impact on form, fit or function of the current product.

Figure 2. 1.93 - 1.99 GHz Test Fixture Component Layout

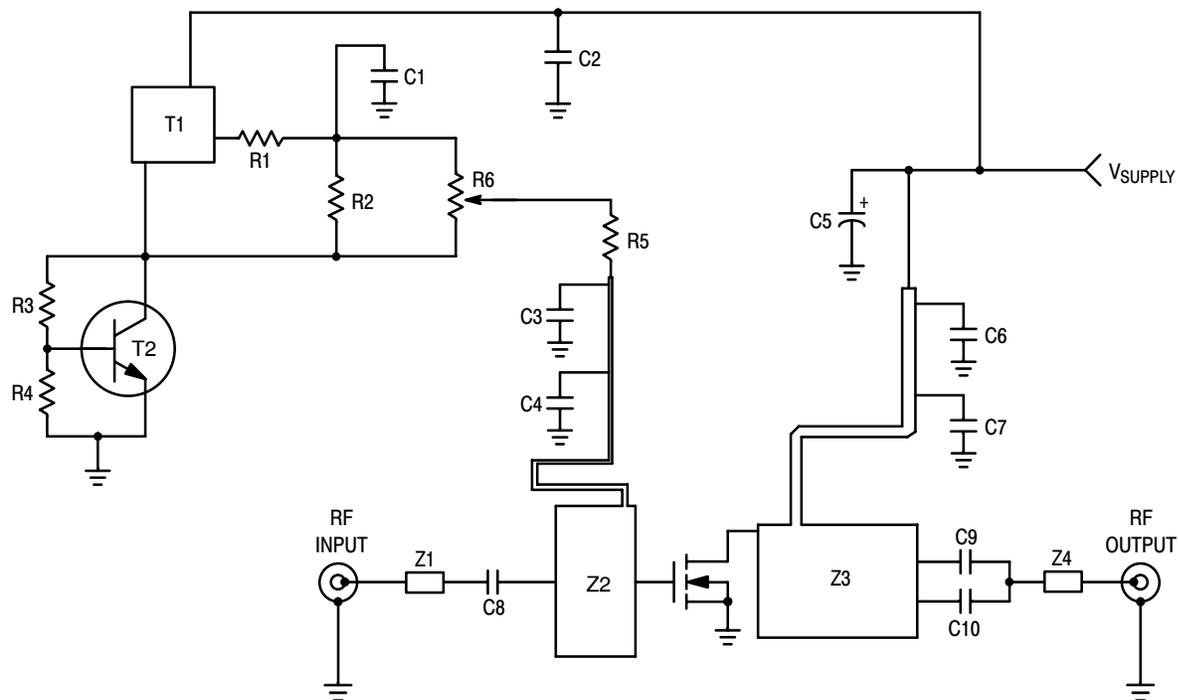

C1, C3	1 $\mu$ F Chip Capacitors (0805)	R5	10 k $\Omega$ Chip Resistor (0603)
C2	0.1 $\mu$ F Chip Capacitor (0805)	R6	5 k $\Omega$ , SMD Potentiometer
C4	1 nF Chip Capacitor (0805)	T1	LP2951 Micro-8 Voltage Regulator
C5	220 $\mu$ F, 50 V Electrolytic Capacitor	T2	BC847 SOT-23 NPN Transistor
C6, C7	8.2 pF, 100A Chip Capacitors	Z1	0.491" x 0.110" Microstrip
C8, C9, C10	22 pF, 100A Chip Capacitors	Z2	0.756" x 1.260" Microstrip
R1	10 $\Omega$ Chip Resistor (0805)	Z3	1.433" x 1.260" Microstrip
R2, R3	1 k $\Omega$ Chip Resistors (0805)	Z4	0.567" x 0.110" Microstrip
R4	2.2 k $\Omega$ Chip Resistor (0805)		Substrate = 0.5 mm Teflon <sup>®</sup> Glass

**Figure 3. 1.93 - 1.99 GHz Demo Board Schematic**

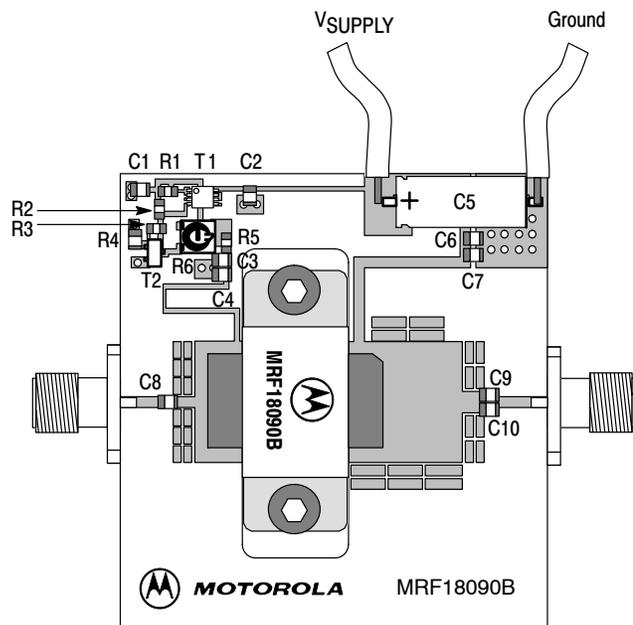

Freescale has begun the transition of marking Printed Circuit Boards (PCBs) with the Freescale Semiconductor signature/logo. PCBs may have either Motorola or Freescale markings during the transition period. These changes will have no impact on form, fit or function of the current product.

**Figure 4. 1.93 - 1.99 GHz Demo Board Component Layout**

## TYPICAL CHARACTERISTICS

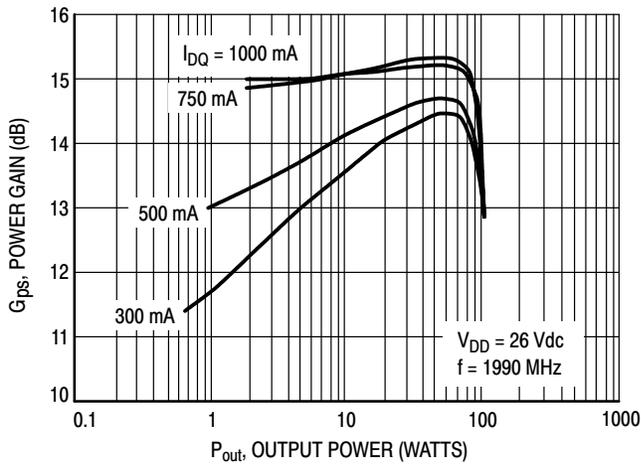

Figure 5. Power Gain versus Output Power

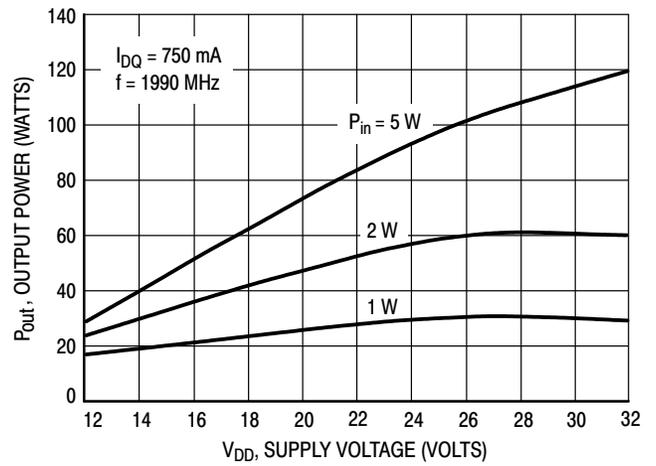

Figure 6. Output Power versus Supply Voltage

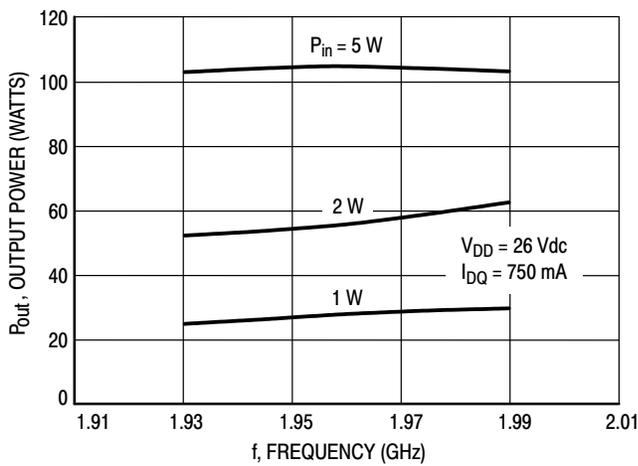

Figure 7. Output Power versus Frequency

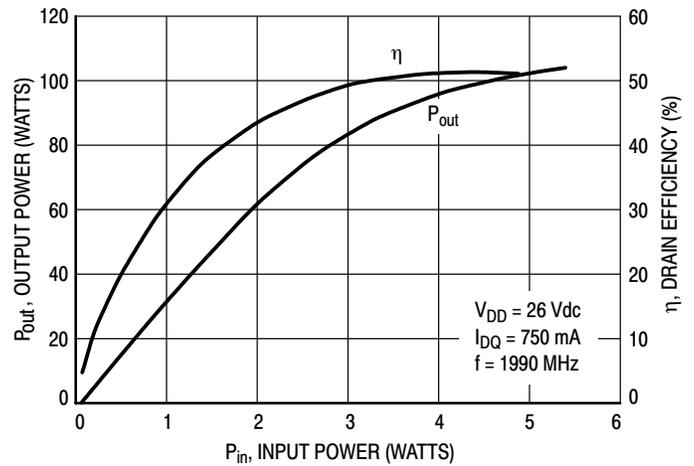

Figure 8. Output Power and Efficiency versus Input Power

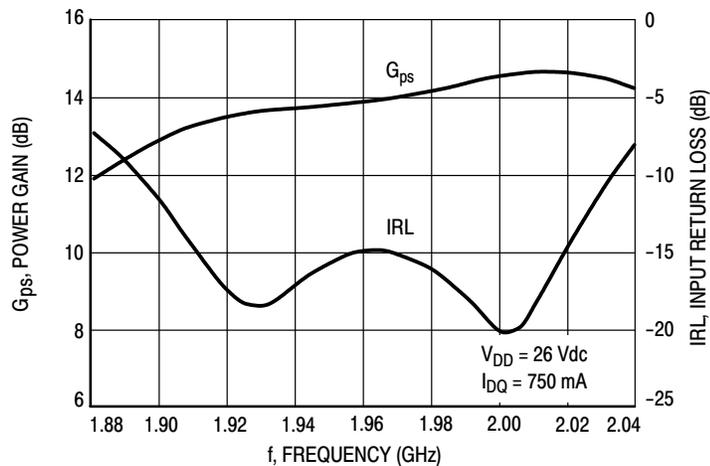
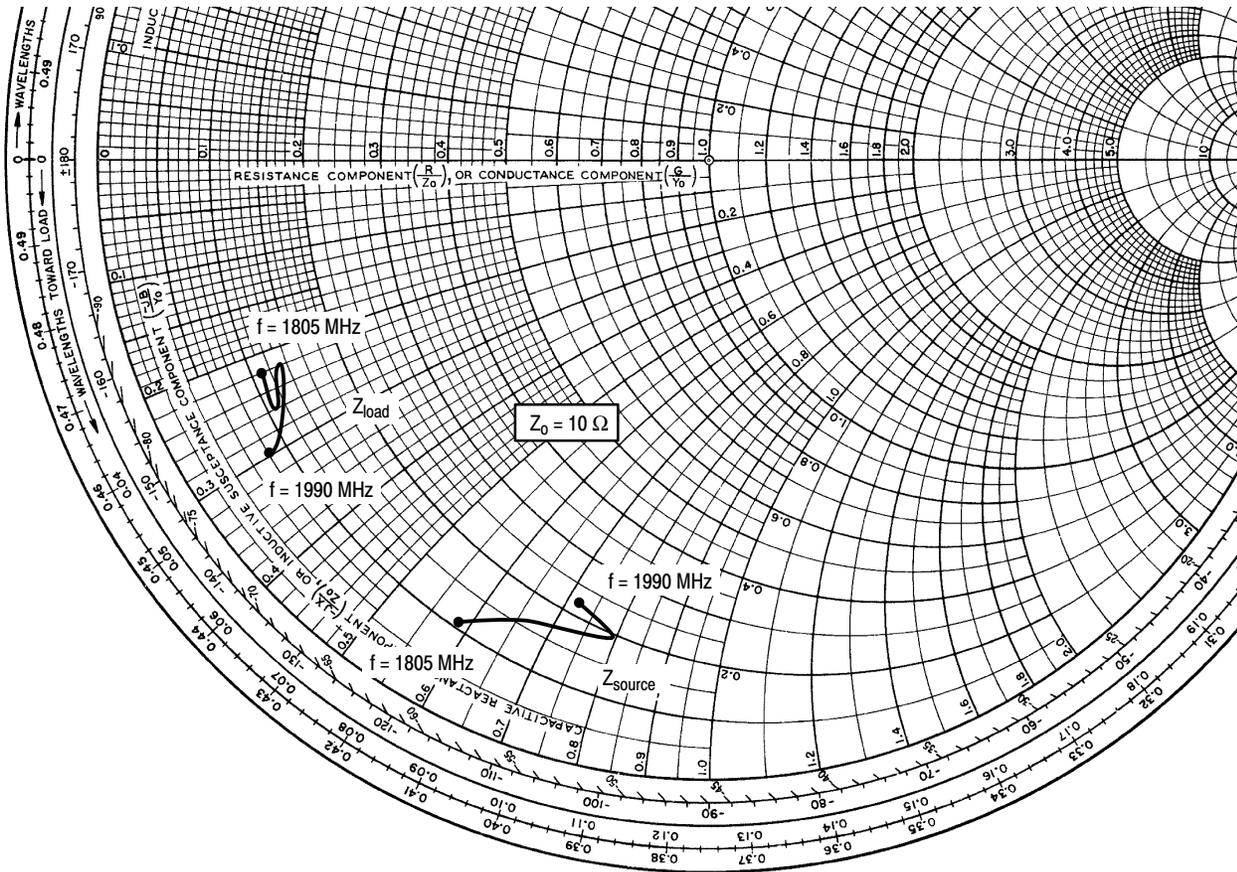

Figure 9. Wideband Gain and IRL (at Small Signal)



$V_{DD} = 26\text{ V}$ ,  $I_{DQ} = 750\text{ mA}$ ,  $P_{out} = 90\text{ Watts (CW)}$

f MHz	$Z_{source}$ $\Omega$	$Z_{load}$ $\Omega$
1805	$1.10 - j5.85$	$1.15 - j2.16$
1880	$1.56 - j6.75$	$1.13 - j2.60$
1930	$2.05 - j8.00$	$1.30 - j2.23$
1990	$2.30 - j7.30$	$0.82 - j2.90$

$Z_{source}$  = Test circuit impedance as measured from gate to ground.

$Z_{load}$  = Test circuit impedance as measured from drain to ground.

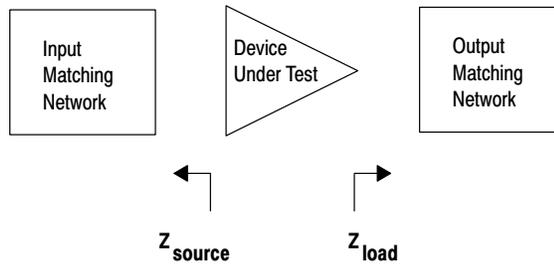
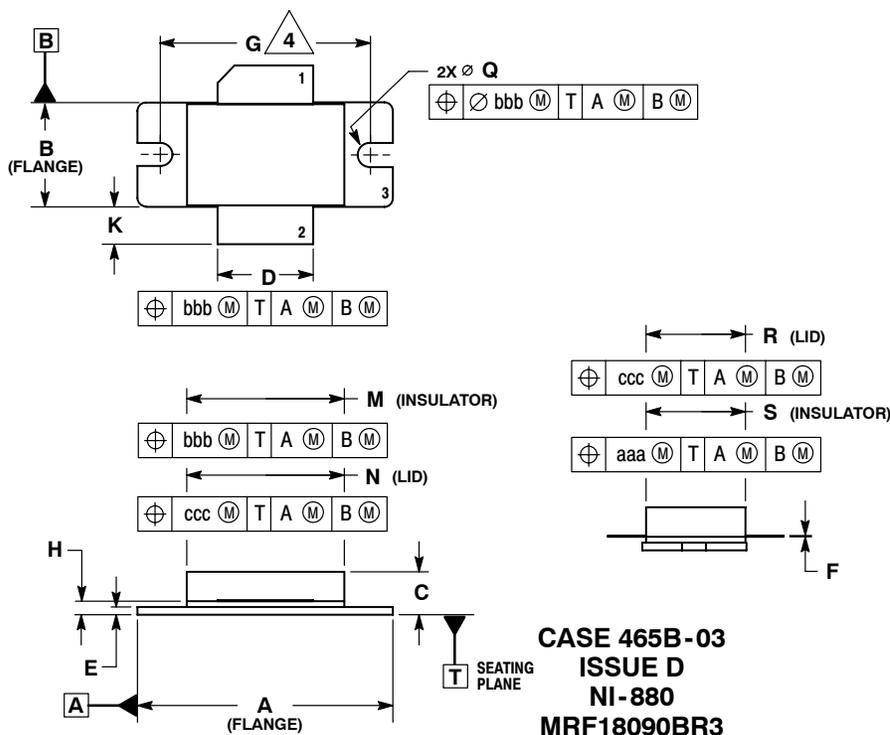

Figure 10. Large Signal Source and Load Impedance

## PACKAGE DIMENSIONS



- NOTES:
1. DIMENSIONING AND TOLERANCING PER ANSI Y14.5M-1994.
  2. CONTROLLING DIMENSION: INCH.
  3. DIMENSION H IS MEASURED 0.030 (0.762) AWAY FROM PACKAGE BODY.
  4. RECOMMENDED BOLT CENTER DIMENSION OF 1.16 (29.57) BASED ON M3 SCREW.

DIM	INCHES		MILLIMETERS	
	MIN	MAX	MIN	MAX
A	1.335	1.345	33.91	34.16
B	0.535	0.545	13.6	13.8
C	0.147	0.200	3.73	5.08
D	0.495	0.505	12.57	12.83
E	0.035	0.045	0.89	1.14
F	0.003	0.006	0.08	0.15
G	1.100 BSC		27.94 BSC	
H	0.057	0.067	1.45	1.70
K	0.175	0.205	4.44	5.21
M	0.872	0.888	22.15	22.55
N	0.871	0.889	19.30	22.60
Q	$\varnothing$ 1.118	$\varnothing$ 1.138	$\varnothing$ 3.00	$\varnothing$ 3.51
R	0.515	0.525	13.10	13.30
S	0.515	0.525	13.10	13.30
aaa	0.007 REF		0.178 REF	
bbb	0.010 REF		0.254 REF	
ccc	0.015 REF		0.381 REF	

- STYLE 1:
- PIN 1. DRAIN
  - GATE
  - SOURCE

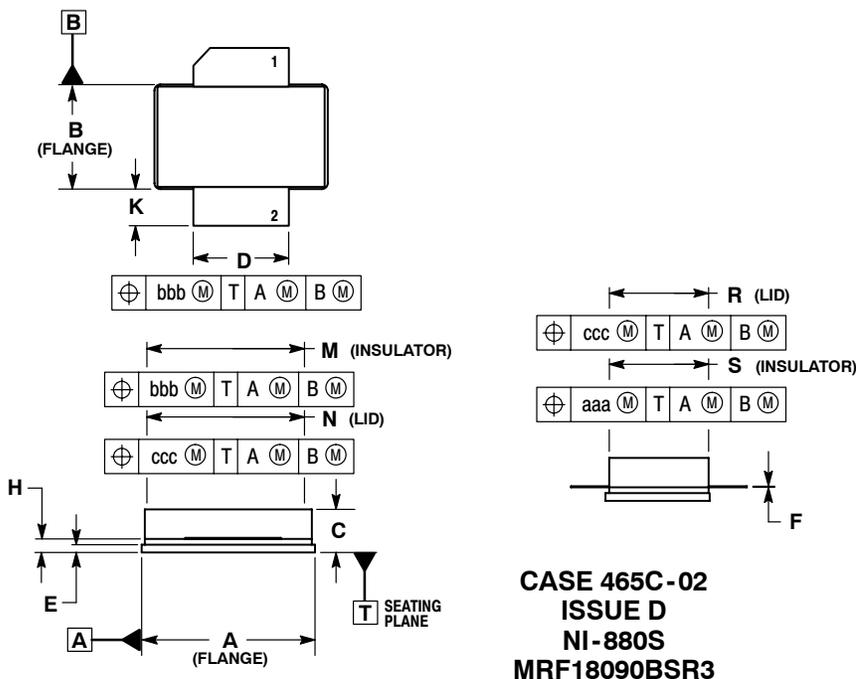

- NOTES:
1. DIMENSIONING AND TOLERANCING PER ANSI Y14.5M-1994.
  2. CONTROLLING DIMENSION: INCH.
  3. DIMENSION H IS MEASURED 0.030 (0.762) AWAY FROM PACKAGE BODY.

DIM	INCHES		MILLIMETERS	
	MIN	MAX	MIN	MAX
A	0.905	0.915	22.99	23.24
B	0.535	0.545	13.60	13.80
C	0.147	0.200	3.73	5.08
D	0.495	0.505	12.57	12.83
E	0.035	0.045	0.89	1.14
F	0.003	0.006	0.08	0.15
H	0.057	0.067	1.45	1.70
K	0.170	0.210	4.32	5.33
M	0.872	0.888	22.15	22.55
N	0.871	0.889	19.30	22.60
R	0.515	0.525	13.10	13.30
S	0.515	0.525	13.10	13.30
aaa	0.007 REF		0.178 REF	
bbb	0.010 REF		0.254 REF	
ccc	0.015 REF		0.381 REF	

- STYLE 1:
- PIN 1. DRAIN
  - GATE
  - SOURCE

## **How to Reach Us:**

### **Home Page:**

www.freescale.com

### **E-mail:**

support@freescale.com

### **USA/Europe or Locations Not Listed:**

Freescale Semiconductor  
Technical Information Center, CH370  
1300 N. Alma School Road  
Chandler, Arizona 85224  
+1-800-521-6274 or +1-480-768-2130  
support@freescale.com

### **Europe, Middle East, and Africa:**

Freescale Halbleiter Deutschland GmbH  
Technical Information Center  
Schatzbogen 7  
81829 Muenchen, Germany  
+44 1296 380 456 (English)  
+46 8 52200080 (English)  
+49 89 92103 559 (German)  
+33 1 69 35 48 48 (French)  
support@freescale.com

### **Japan:**

Freescale Semiconductor Japan Ltd.  
Headquarters  
ARCO Tower 15F  
1-8-1, Shimo-Meguro, Meguro-ku,  
Tokyo 153-0064  
Japan  
0120 191014 or +81 3 5437 9125  
support.japan@freescale.com

### **Asia/Pacific:**

Freescale Semiconductor Hong Kong Ltd.  
Technical Information Center  
2 Dai King Street  
Tai Po Industrial Estate  
Tai Po, N.T., Hong Kong  
+800 2666 8080  
support.asia@freescale.com

### **For Literature Requests Only:**

Freescale Semiconductor Literature Distribution Center  
P.O. Box 5405  
Denver, Colorado 80217  
1-800-441-2447 or 303-675-2140  
Fax: 303-675-2150  
LDCForFreescaleSemiconductor@hibbertgroup.com

Information in this document is provided solely to enable system and software implementers to use Freescale Semiconductor products. There are no express or implied copyright licenses granted hereunder to design or fabricate any integrated circuits or integrated circuits based on the information in this document.

Freescale Semiconductor reserves the right to make changes without further notice to any products herein. Freescale Semiconductor makes no warranty, representation or guarantee regarding the suitability of its products for any particular purpose, nor does Freescale Semiconductor assume any liability arising out of the application or use of any product or circuit, and specifically disclaims any and all liability, including without limitation consequential or incidental damages. "Typical" parameters that may be provided in Freescale Semiconductor data sheets and/or specifications can and do vary in different applications and actual performance may vary over time. All operating parameters, including "Typicals", must be validated for each customer application by customer's technical experts. Freescale Semiconductor does not convey any license under its patent rights nor the rights of others. Freescale Semiconductor products are not designed, intended, or authorized for use as components in systems intended for surgical implant into the body, or other applications intended to support or sustain life, or for any other application in which the failure of the Freescale Semiconductor product could create a situation where personal injury or death may occur. Should Buyer purchase or use Freescale Semiconductor products for any such unintended or unauthorized application, Buyer shall indemnify and hold Freescale Semiconductor and its officers, employees, subsidiaries, affiliates, and distributors harmless against all claims, costs, damages, and expenses, and reasonable attorney fees arising out of, directly or indirectly, any claim of personal injury or death associated with such unintended or unauthorized use, even if such claim alleges that Freescale Semiconductor was negligent regarding the design or manufacture of the part.

Freescale™ and the Freescale logo are trademarks of Freescale Semiconductor, Inc. All other product or service names are the property of their respective owners.  
© Freescale Semiconductor, Inc. 2006. All rights reserved.

